



**RỒNG VÀNG
TECHNOLOGY**



Small Circular Electrical Connector

2PX Series

extended model range

substitutes of Russian

2RMT, 2RMDT,

2RMG, 2RMGD,

2RMGP, 2RMGPD

www.rong-vang-technology.vn



Description

Connectors of 2PX type (extended model range) are intended for use in DC and AC (frequency up to 3 MHz) electrical circuits

The connectors are produced in four versions: unsealed Plugs, unsealed Receptacles, hermetically sealed Receptacles and hermetically feed through bulkhead

The connectors are manufactured without backshells or with backshells

Depending on the connecting cable the connectors may be of shielding or non-shielding design in this case the connector's design remains wholly unchanged except for the terminating nut of the backshell

The connectors have threaded coupling

Polarization – one type, not indicated

Contact plating:

- PX – gold, silver;
- PX-M, PX-C – nickel

Contacts: \varnothing 1.0 mm; \varnothing 1.5 mm; \varnothing 2.0 mm; \varnothing 3.0 mm, non-removable, for soldering wires

Connectors of PX, PX-M, PX-C have nine different contact group and are not intermated

The connectors are manufactured in all climatic conditions in accordance with the technical conditions GEO.364.126TU



Technical features

Description	Values
Shell material	aluminum
Contact material	copper alloy
Sealing ring material	silicone rubber
Operating temperature	up -60°C to +100°C (unsealed) up -60°C to +200°C (hermetically sealed)
Vibration	up to 5000 Hz at 50 g
Impact	500 g once and 100 g multiple times
1 bar differential pressure, leakage	≤ 0.1 l/h
Working voltage	700 V
Insulation resistance	≥ 5000 MΩ (standard atmospheric conditions)
Durability	500 cycles
Technical conditions	GEO.364.126TU
Guarantee period	7 years

Electrical

Max current rating per contact

∅ 1.0	∅ 1.5	∅ 2.0	∅ 3.0
5 A	10 A	20 A	40 A

Contact resistance







∅ 1.0	∅ 1.5	∅ 2.0	∅ 3.0
≤ 5 mΩ	≤ 2,5 mΩ	≤ 1,6 mΩ	≤ 0,8 mΩ

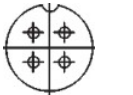
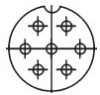

Ordering information

Basic series	2PX	18	J	4	P	5
Shell size:						
For unsealed Plugs and Receptacles: 14, 18, 22, 24, 27, 30, 33, 36, 39, 42, 45						
For hermetically sealed Receptacles & hermetically feed through bulkhead: 14, 18, 22, 24, 27, 30, 33, 36, 39, 42						
Contact Type:						
J: Pin						
K: Socket						
Number of contacts: 4, 7, 8, 10, 19, 20, 22, 24, 30, 32, 42, 45, 50						
Connector Type:						
Omit: unsealed Plug						
A: unsealed Receptacle						
M: hermetically sealed Receptacle with pin contacts only						
C: hermetically feed through bulkhead with pin contacts only						
Backshell Type:						
Omit: without backshell						
Omit: for hermetically feed through bulkhead PX-C						
P: straight EMI/RFI Backshell						
Q: straight non-shielding Backshell						
R: elbow EMI/RFI Backshell (not available for Shell size 45)						
S: elbow non-shielding Backshell (not available for Shell size 45)						
Contact Group:						
1: contacts \varnothing 1 mm, only						
2: contacts \varnothing 1 mm + \varnothing 1.5 mm						
3: contacts \varnothing 2 mm + \varnothing 3 mm						
4: contacts \varnothing 1 mm + \varnothing 3 mm						
5: contacts \varnothing 1.5 mm, only						
6: contacts \varnothing 1.5 mm + \varnothing 3 mm						
7: contacts \varnothing 1.5 mm + \varnothing 2 mm + \varnothing 3 mm						
8: contacts \varnothing 1.5 mm + \varnothing 2 mm						
9: contacts \varnothing 3 mm, only						
Contact plating:						
Omit: Silver for unsealed Plugs and unsealed Receptacles or Nickel for hermetically sealed Receptacles PX-M & hermetically feed through bulkhead PX-C						
B: Gold for unsealed Plugs and unsealed Receptacles						
Plug thread:						
Omit: for unsealed Plug						
U: for Left Plug (for mating with hermetically feed through bulkhead 2PX-C)						

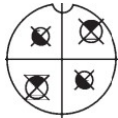
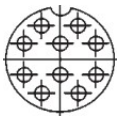
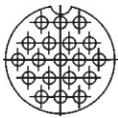
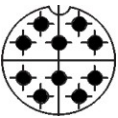
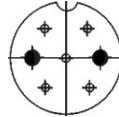
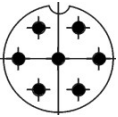
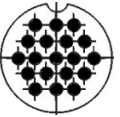
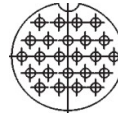
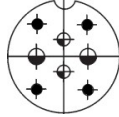
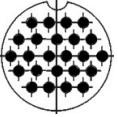
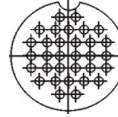
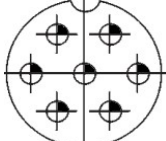
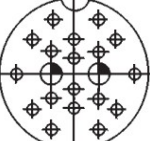
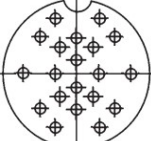
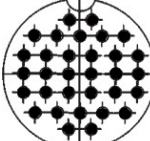
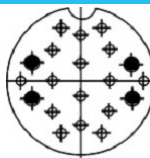
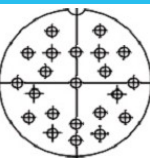
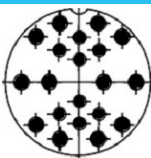
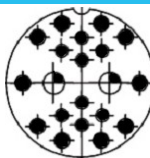
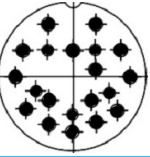
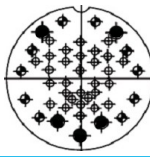
Contact layouts

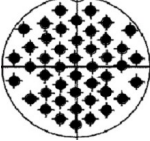
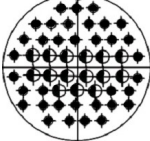
Shell Size	Number of Contacts - Contact Group				Contact Diameter, mm Symbol			
	4-1	18	7-1	4-5	Ø 1.0	Ø 1.5	Ø 2.0	Ø 3.0
14								
		4-3	10-1		19-1	10-5		
22				24				
	27	7-2	7-5		19-5	24-1		
								
30	8-7		24-5		32-1			
								
33	7-9	20-4	20-6	20-5				
								
36	20-2	22-1	20-5	20-6				
								
39	22-5		42-2					
								
42	30-2	50-2	45-5	45	50-8			
								

Dimensions

Receptacles & Plugs, PX type, without backshells

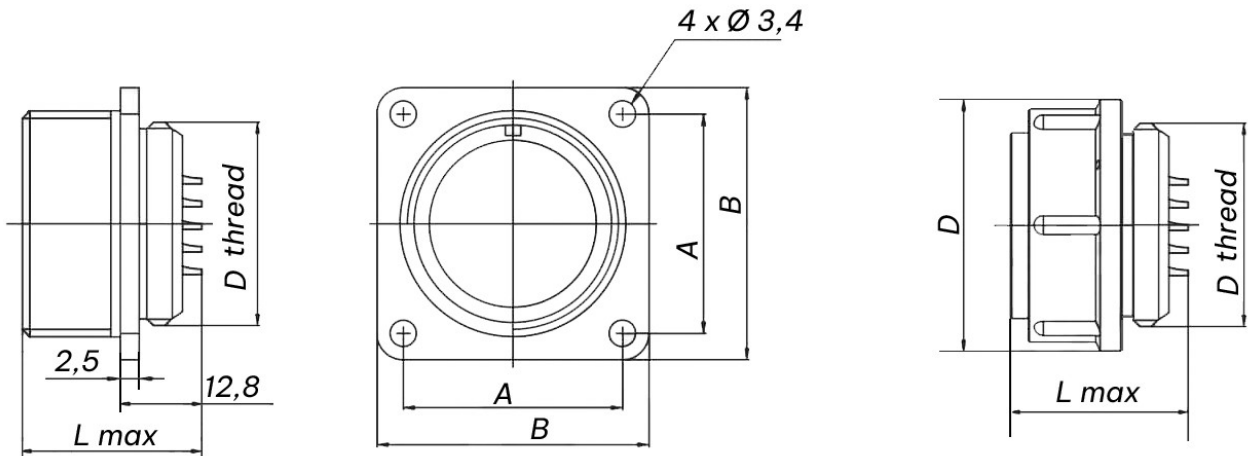

Receptacles

Plugs

Shell size	D thread left	A	B	D max	L max
14	M14X1	17	24	22	25
18	M18X1	20	27	25	25
22	M22X1	23	30	29	27
24	M24X1	26	33	32	25
27	M27X1	29	36	35	25
30	M30X1	31	38	39	27
33	M33X1	32	40	42	27
36	M36X1	35	43	45	25
39	M39X1	37	46	48	25
42	M42X1	40	49	51	25
45	M45X1	43	52	54	27

Straight EMI/RFI Backshell, P type

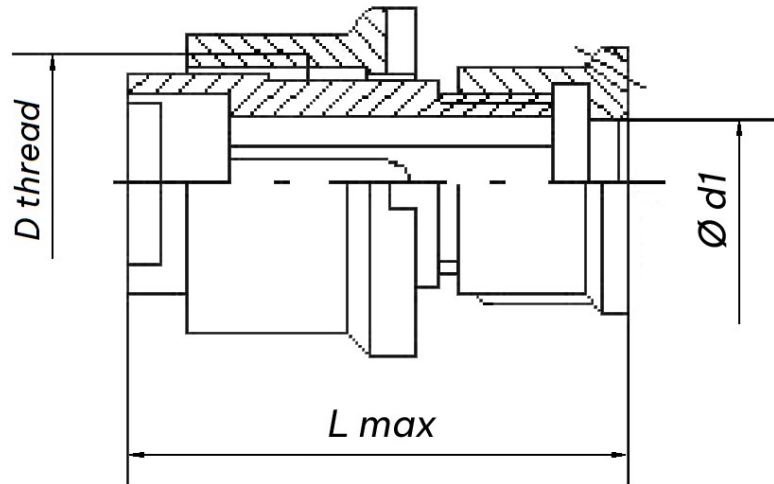

Shell size	D thread left	d1	L max
14	M14X1	6,5	28,7
18	M18X1	10,5	28,7
22	M22X1	14	28,7
24	M24X1	16	34,7
27	M27X1	18	34,7
30	M30X1	19	34,7
33	M33X1	23	39,7
36	M36X1	23	39,7
39	M39X1	24	39,7
42	M42X1	29	39,7
45	M45X1	29	39,7

Straight non-shielding Backshell, Q type

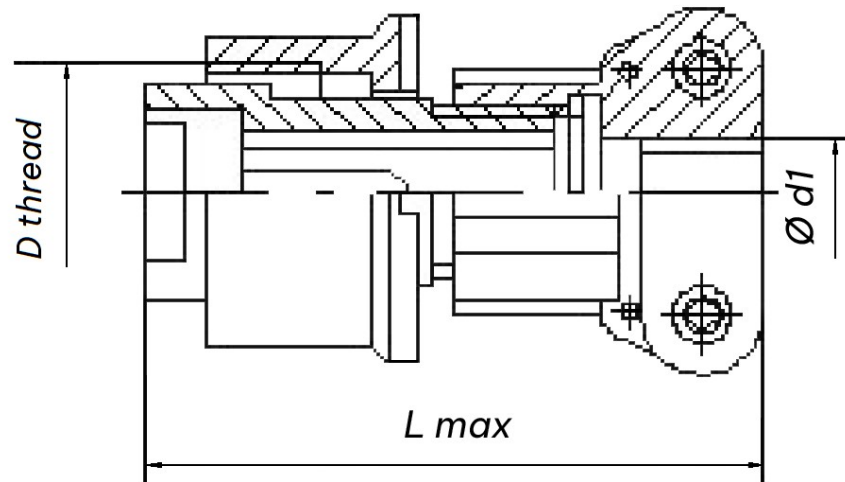

Shell size	D thread left	d1	L max
14	M14X1	6,5	34
18	M18X1	10,5	34
22	M22X1	14,5	36,6
24	M24X1	16,6	43
27	M27X1	18,5	43
30	M30X1	20,5	43
33	M33X1	22,5	48
36	M36X1	22,5	48
39	M39X1	24,5	48
42	M42X1	30,5	48
45	M45X1	30,5	48

Elbow EMI/RFI Backshell, R type

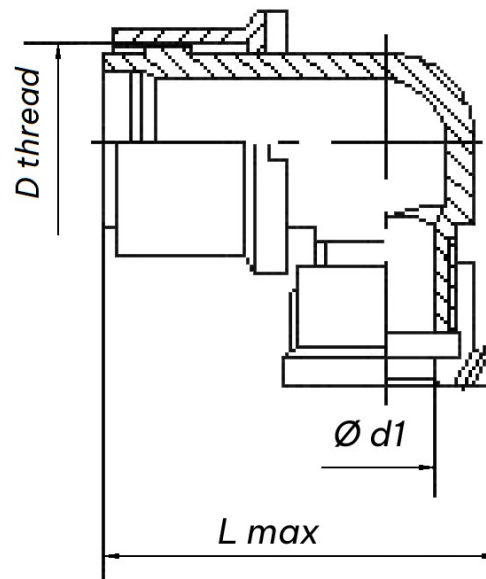

Shell size	D thread left	d1	L max
14	M14X1	6,5	31
18	M18X1	10,5	34
22	M22X1	14	41
24	M24X1	16	43
27	M27X1	18	46
30	M30X1	19	48
33	M33X1	23	53
36	M36X1	23	50
39	M39X1	24	53
42	M42X1	29	58

Elbow non-shielding Backshell, S type

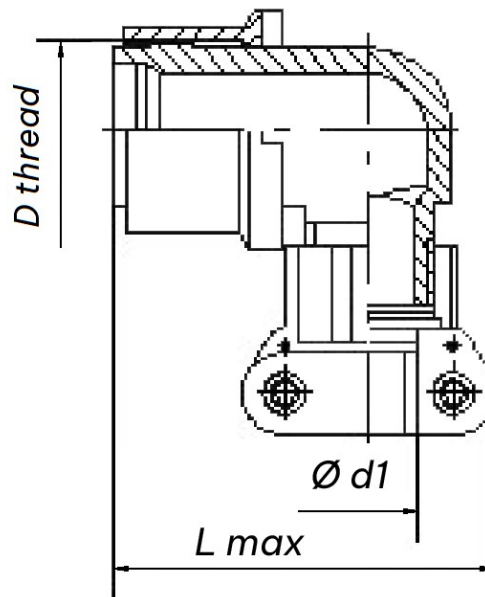

Shell size	D thread left	d1	L max
14	M14X1	6,5	35
18	M18X1	10,5	38
22	M22X1	14,5	42,5
24	M24X1	16,6	44,5
27	M27X1	18,5	46,5
30	M30X1	20,5	48,5
33	M33X1	22,5	54,5
36	M36X1	22,5	51,5
39	M39X1	24,5	54,5
42	M42X1	30,5	61,5

Receptacles PX-M type, without backshell

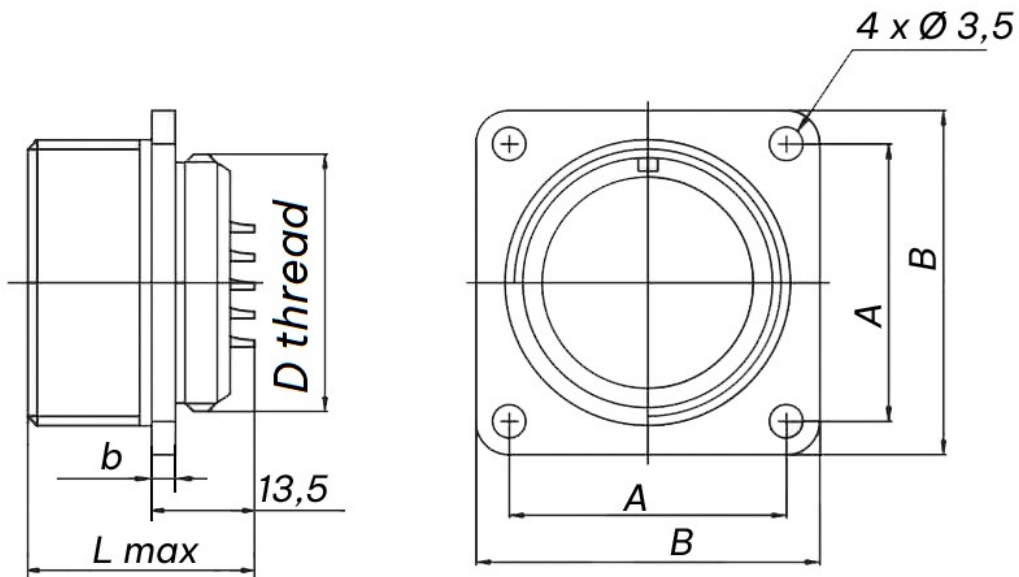

Shell size	D thread left	A	B	b	L max
14	M14X1	17	24	2.5	26.5
18	M18X1	20	27	1.8	26.5
22	M22X1	23	30	2.5	28.5
24	M24X1	26	33	1.8	26.5
27	M27X1	29	36	2.5	26.5
30	M30X1	31	38	2.5	28.5
33	M33X1	32	40	1.8	28.5
36	M36X1	35	43	2.5	28.5
39	M39X1	37	46	1.8	26.5
42	M42X1	40	49	2.5	26.5

Feed through bulkhead, PX-C type

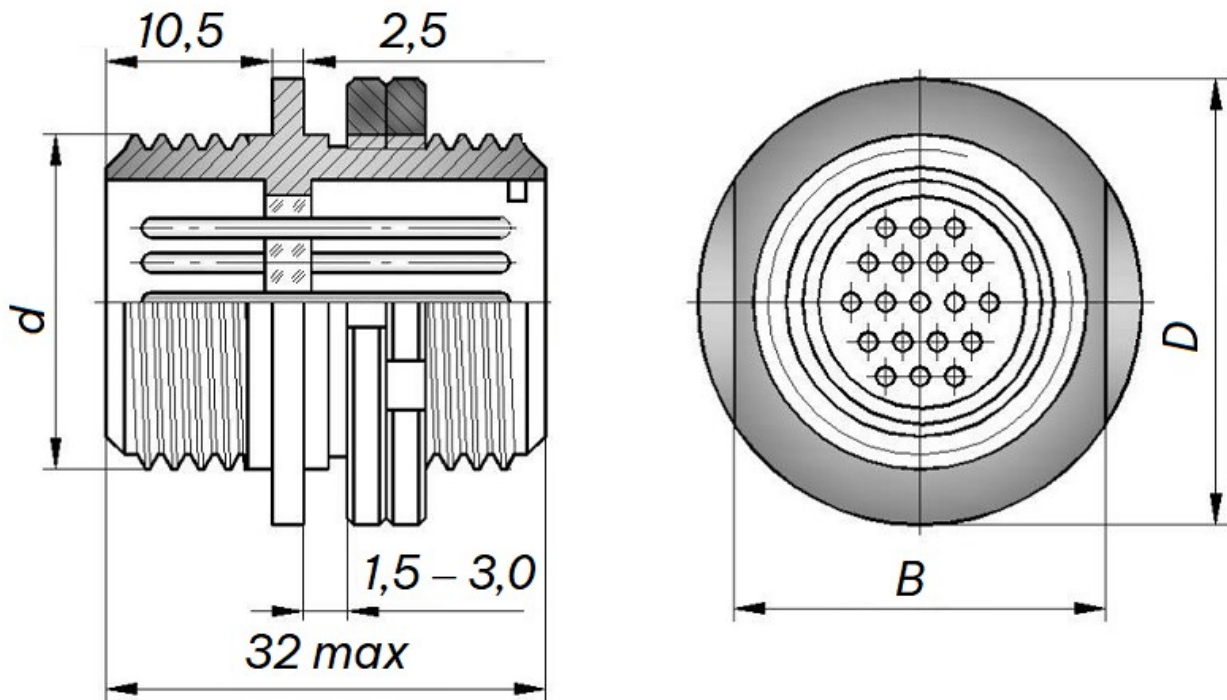

Shell size	d	D	B
14	M16X1	25	22
18	M20X1	29	26
22	M24X1	33	30
24	M27X1,5	36	33
27	M30X1,5	39	36
30	M33X1,5	42	39
33	M36X1,5	45	42
36	M39X1,5	48	45
39	M42X1,5	51	48
42	M45X1,5	54	51

Protective caps

Ordering information

Basic series	2PM	14	T	C
Shell size: 14, 18, 22, 24, 27, 30, 33, 36, 39, 42, 45				
Caps type				
Z: cap for receptacle				
T: cap for plug				
Attachment Style:				
C: With chain and small eyelet				

Dimensions

(Versions with Chain and Small Eyelet Shown)

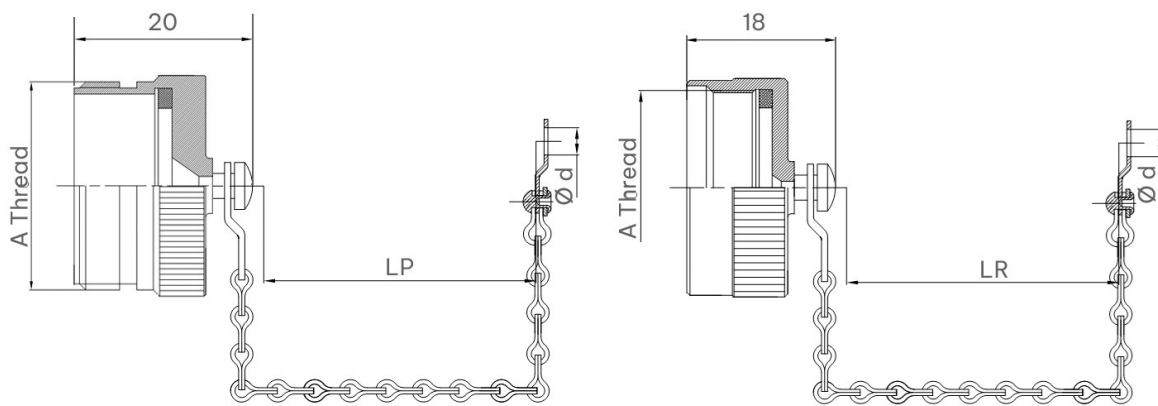

for plugs

for receptacles

Shell size	A Thread	Ø d	LP	LR
14	M16x1	3,2	38	29
18	M20x1	3,2	47	38
22	M24x1	3,2	47	38
24	M27x1,5	3,2	47	38
27	M30x1,5	3,2	56	47
30	M33x1,5	3,2	56	47
33	M36x1,5	3,2	56	47
36	M39x1,5	3,2	74	74
39	M42x1,5	4,0	74	74
42	M45x1,5	4,0	74	74
45	M48x1,5	4,0	74	74



Cross reference list

Caps for Receptacles

Russian Part No.	ALLCONN Part No.
ЭП2РМТ-14	2PM14ZC
ЭП2РМТ-18	2PM18ZC
ЭП2РМТ-22	2PM22ZC
ЭП2РМТ-24	2PM24ZC
ЭП2РМТ-27	2PM27ZC
ЭП2РМТ-30	2PM30ZC
ЭП2РМТ-33	2PM33ZC
ЭП2РМТ-36	2PM36ZC
ЭП2РМТ-39	2PM39ZC
ЭП2РМТ-42	2PM42ZC
ЭП2РМТ-45	2PM45ZC

Caps for Plugs

Russian Part No.	ALLCONN Part No.
ЭК2РМТ-14	2PM14TC
ЭК2РМТ-18	2PM18TC
ЭК2РМТ-22	2PM22TC
ЭК2РМТ-24	2PM24TC
ЭК2РМТ-27	2PM27TC
ЭК2РМТ-30	2PM30TC
ЭК2РМТ-33	2PM33TC
ЭК2РМТ-36	2PM36TC
ЭК2РМТ-39	2PM39TC
ЭК2РМТ-42	2PM42TC
ЭК2РМТ-45	2PM45TC

CÔNG TY TNHH RỒNG VÀNG TECHNOLOGY

Địa chỉ: 48/5 Phong Chau str,

Nam Nha Trang Ward,

Khanh Hoa Province, Vietnam, 57123

Sđt: +84 79.219.2707

www.rong-vang-technology.vn

www.rong-vang-technology.vn