



RỒNG VÀNG
TECHNOLOGY



Circular Electrical Connector

PRB Series

substitutes of Russian 2RTT

www.rong-vang-technology.vn



Description

Connectors of PRB type are intended for use in DC and AC (frequency up to 3 MHz) electrical circuits with voltage up to 850 V (as peak)

The connectors are produced in two versions: Plugs and Receptacles

The connectors are manufactured:

- Receptacles with backshell (straight shielding, straight non-shielding, elbow shielding, elbow non-shielding) or without backshells
- Plugs with backshell (straight shielding, straight non-shielding, elbow shielding, elbow non-shielding)

Plugs are delivered with rubber tube or without them

The connectors have threaded coupling.

Contacts:

- \varnothing 1,5 mm; \varnothing 2,5 mm; \varnothing 3,5 mm – non removable
- \varnothing 5,5 mm; \varnothing 9,0 mm – removable

Contact plating: silver

The connectors are manufactured in all climatic conditions in accordance with the technical conditions GEO.364.120TU



Technical features

Description	Values
Shell material	anodized aluminum
Contact material	copper alloy/silver
Operating temperature	up -60°C to +150°C
Vibration	acceleration 10 g (1-1000 HZ)
Impact	acceleration 500 g (once); 35 g (multiple times);
Durability	500 cycles
Technical conditions	GEO.364.120TU

Electrical

Max current rating per contact

Ø 1.5	Ø 2.5	Ø 3.5	Ø 5.5	Ø 9
10 A	25 A	50 A	100 A	200 A























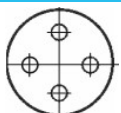

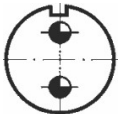
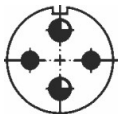
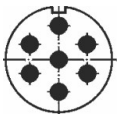

Contact resistance

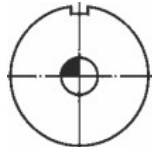
Ø 1.5	Ø 2.5	Ø 3.5	Ø 5.5	Ø 9
≤ 2,5 mΩ	≤ 1 mΩ	≤ 0,5 mΩ	≤ 0,3 mΩ	≤ 0,15 mΩ



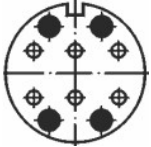

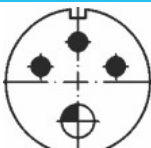

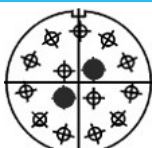
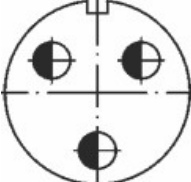
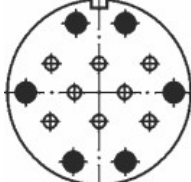
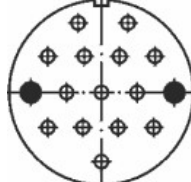
Ordering information

Basic series	PRB	-20	J	6	A	Q
Shell size: 12, 16, 20, 28, 32, 36, 40, 48, 55, 60						
Contact Type:						
J: Pin						
K: Socket						
Contact group						
Connector Type:						
Omit: Plug						
A: Receptacle						
Backshell Type:						
Omit: without backshell for Receptacle only						
P: straight EMI/RFI Backshell						
Q: straight non-shielding Backshell						
R: elbow EMI/RFI Backshell						
S: elbow non-shielding Backshell						

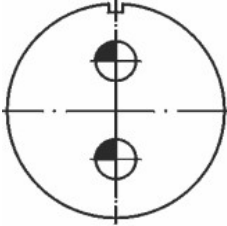
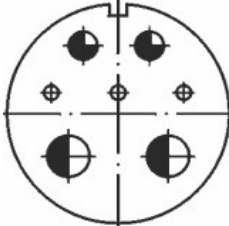
Contact layouts

Shell Size	Number of Contacts - Contact Group				Contact Diameter, mm Symbol					
	1-1	16	1-2	2-3						
12										
					Ø 1.5	Ø 2.5	Ø 3.5	Ø 5.5	Ø 9.0	
20	2-4	3-5	3-38	4-6	4-39	5-40	5-7			
										
28	1-8		2-9		4-10		7-11		7-41	
										
32	1-12			4-13			8-14			
										
	8-42			10-15			12-16			
										
36	4-17		5-18		7-19		15-20			
										
40	3-21			14-22			16-23			
										

Contact layouts

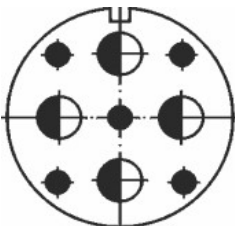
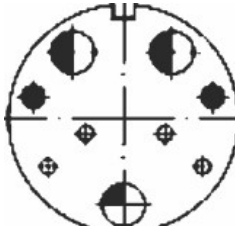
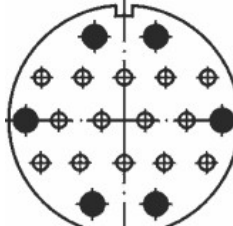
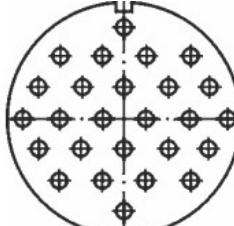
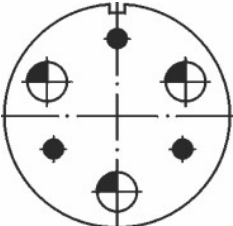
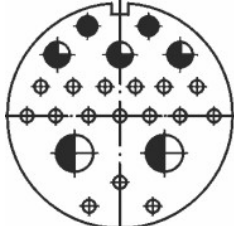
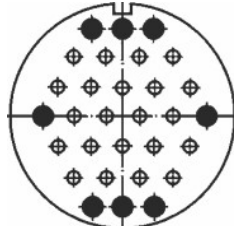
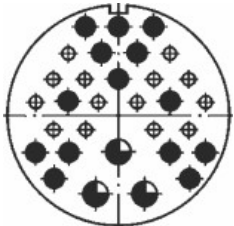
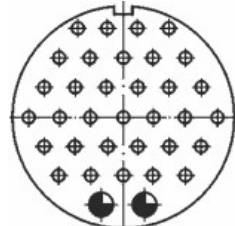
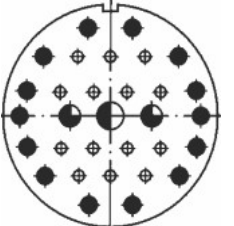
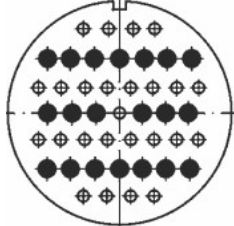
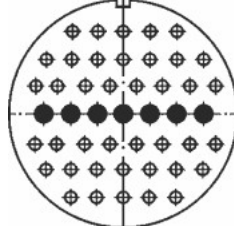
Shell Size	Number of Contacts - Contact Group		Contact Diameter, mm					
			Symbol					
48	2-24	7-25		$\varnothing 1.5$ $\varnothing 2.5$ $\varnothing 3.5$ $\varnothing 5.5$ $\varnothing 9.0$				
				    				
	9-27	9-26	20-28		26-29			
								
55	6-30		23-31		30-32			
								
	31-33			35-34				
								
60	31-35		45-36		47-37			
								

Dimensions

Receptacles without backshell

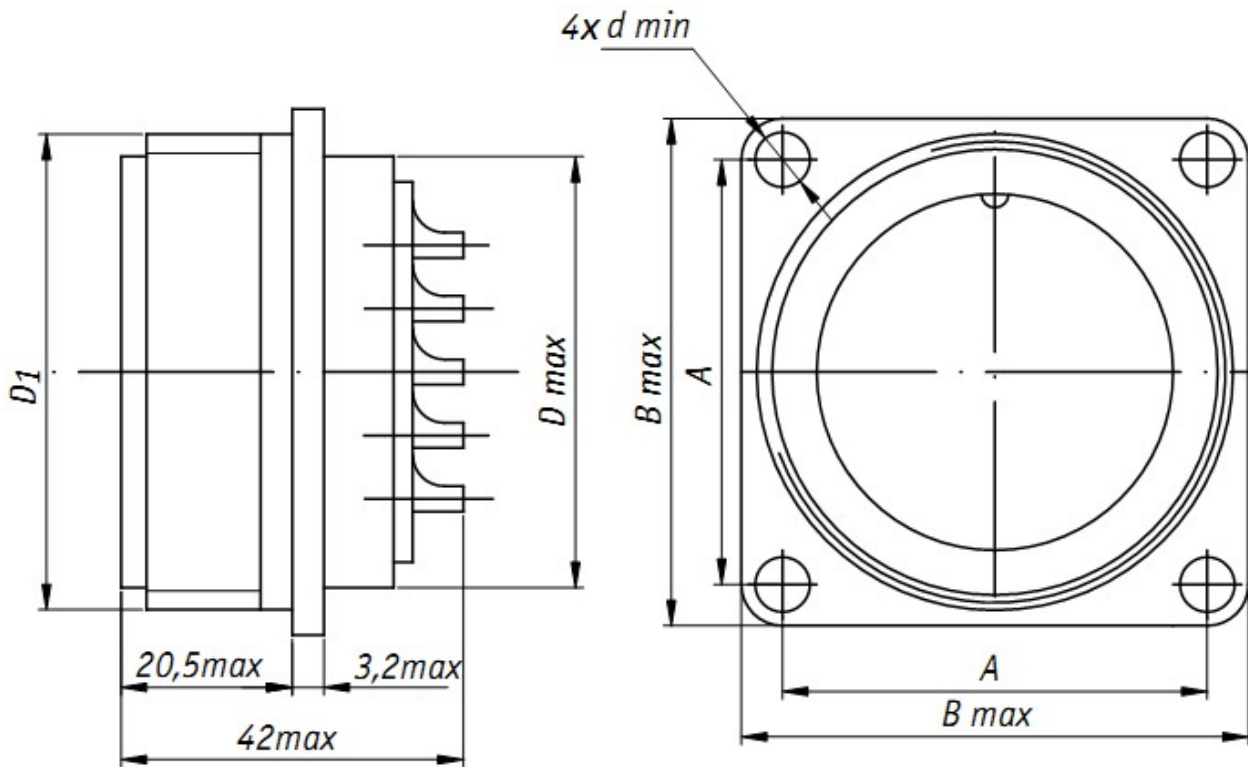

Shell size	A	B	D	D1	d
12	16	22	12	M16x1,5	3,2
16	19	25	16	M20x1,5	3,2
20	22	30	20	M24x1,5	3,2
28	30	38	28	M33x1,5	3,5
32	32	40	32	M36x1,5	3,5
36	34	42	36	M39x1,5	3,5
40	40	48	40	M45x1,5	3,5
48	48	58	48	M52x1,5	4,5
55	52	64	55	M60x1,5	4,5
60	54	68	60	M64x1,5	4,5

Receptacles with straight EMI/RFI Backshell, P type

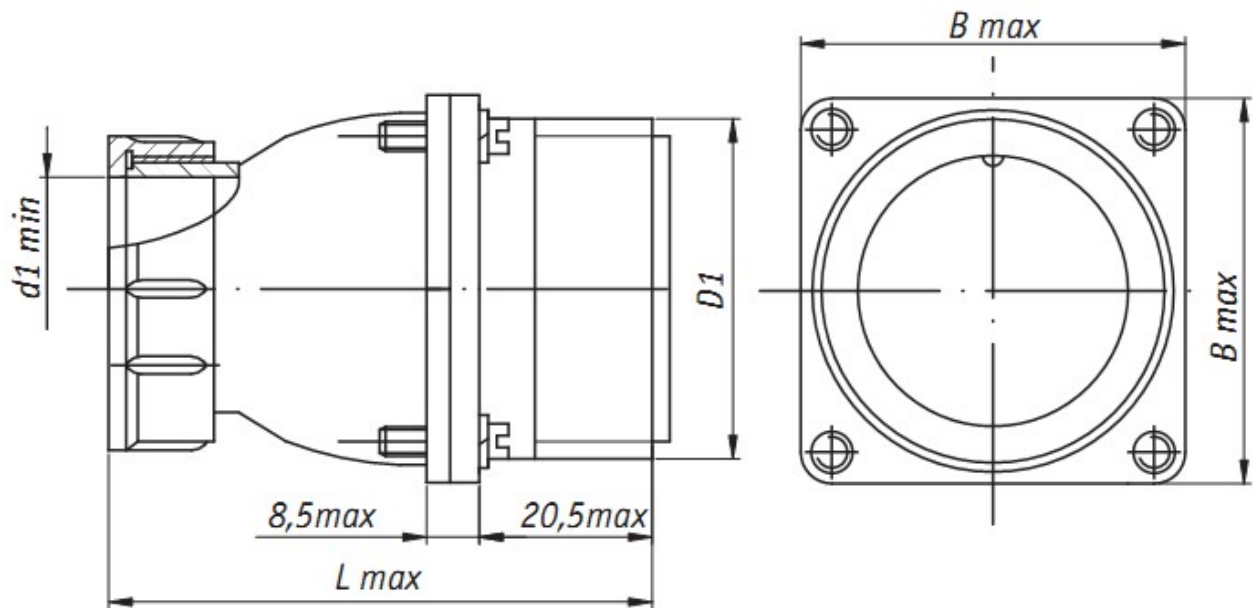

Shell size	B	D1	d1	L
12	22	M16x1,5	7	57
16	25	M20x1,5	11	57
20	30	M24x1,5	17	61
28	38	M33x1,5	24	65
32	40	M36x1,5	24	69
36	42	M39x1,5	28	71
40	48	M45x1,5	30	71
48	58	M52x1,5	36	73
55	64	M60x1,5	45	73
60	68	M64x1,5	48	71

Receptacles with straight non-shielding Backshell, Q type

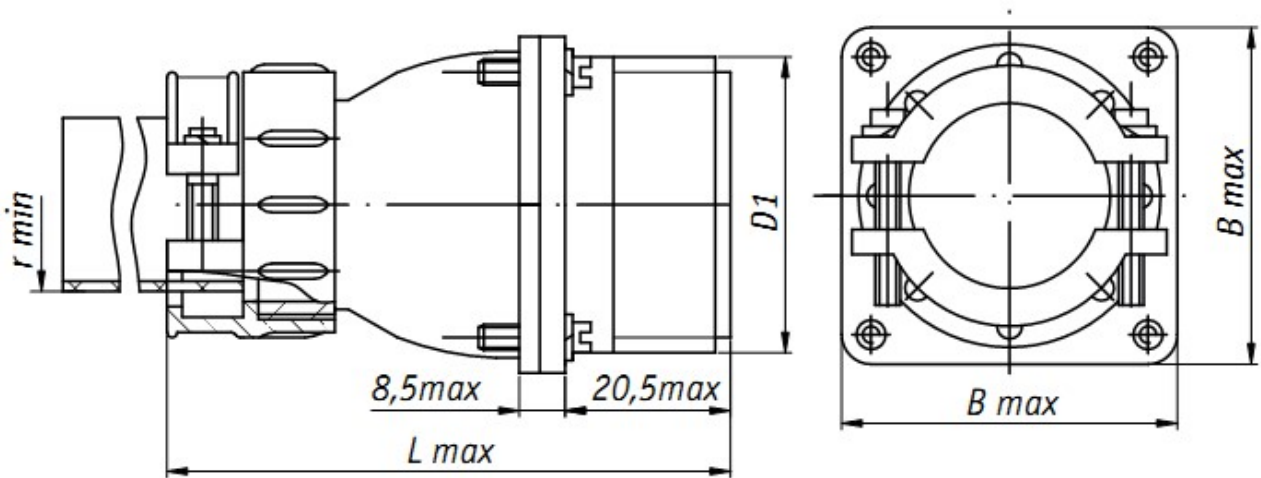

Shell size	B	D1	r	L
12	22	M16x1,5	4	72
16	25	M20x1,5	6	72
20	30	M24x1,5	12	75
28	38	M33x1,5	18	82
32	40	M36x1,5	18	86
36	42	M39x1,5	21	89
40	48	M45x1,5	23	89
48	58	M52x1,5	30	91
55	64	M60x1,5	38	91
60	68	M64x1,5	45	89

Receptacles with elbow EMI/RFI Backshell, R type

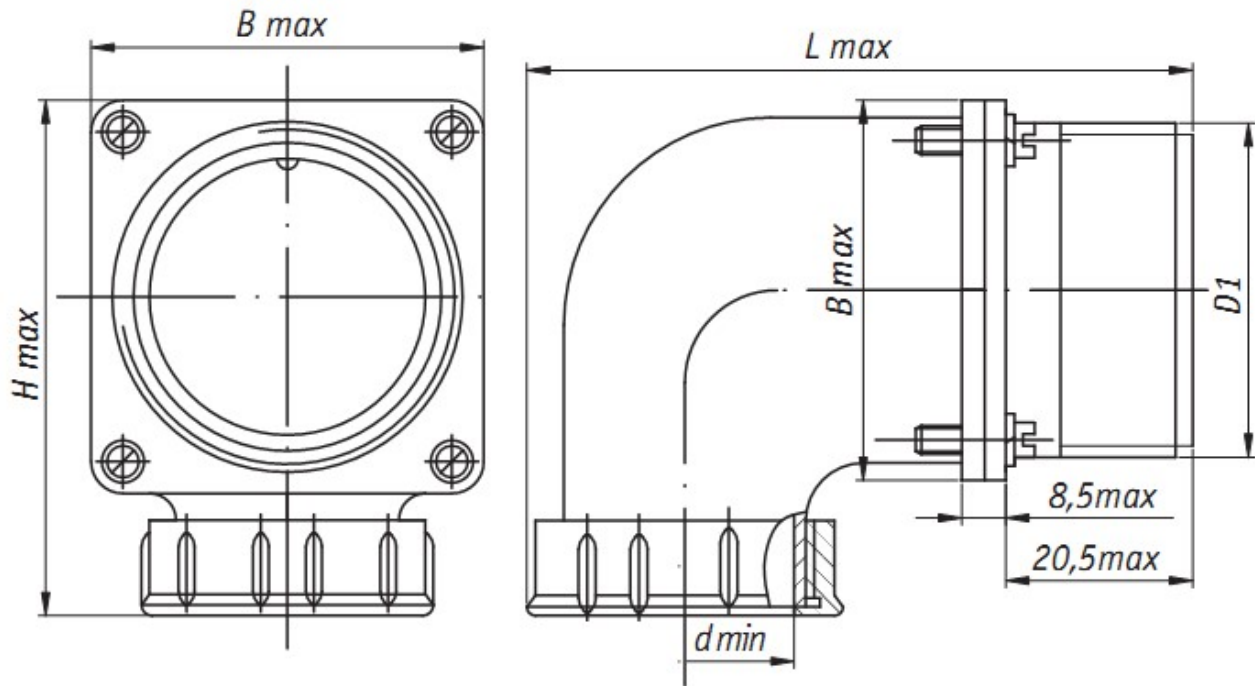

Shell size	B	H	D1	d	L
12	22	41	M16x1,5	7	60
16	25	44	M20x1,5	11	64
20	30	48	M24x1,5	17	72
28	38	59	M33x1,5	24	82
32	40	61	M36x1,5	24	82
36	42	63	M39x1,5	28	85
40	48	69	M45x1,5	30	90
48	58	79	M52x1,5	36	98
55	64	85	M60x1,5	45	106
60	68	89	M64x1,5	48	110

Receptacles with elbow non-shielding Backshell, S type

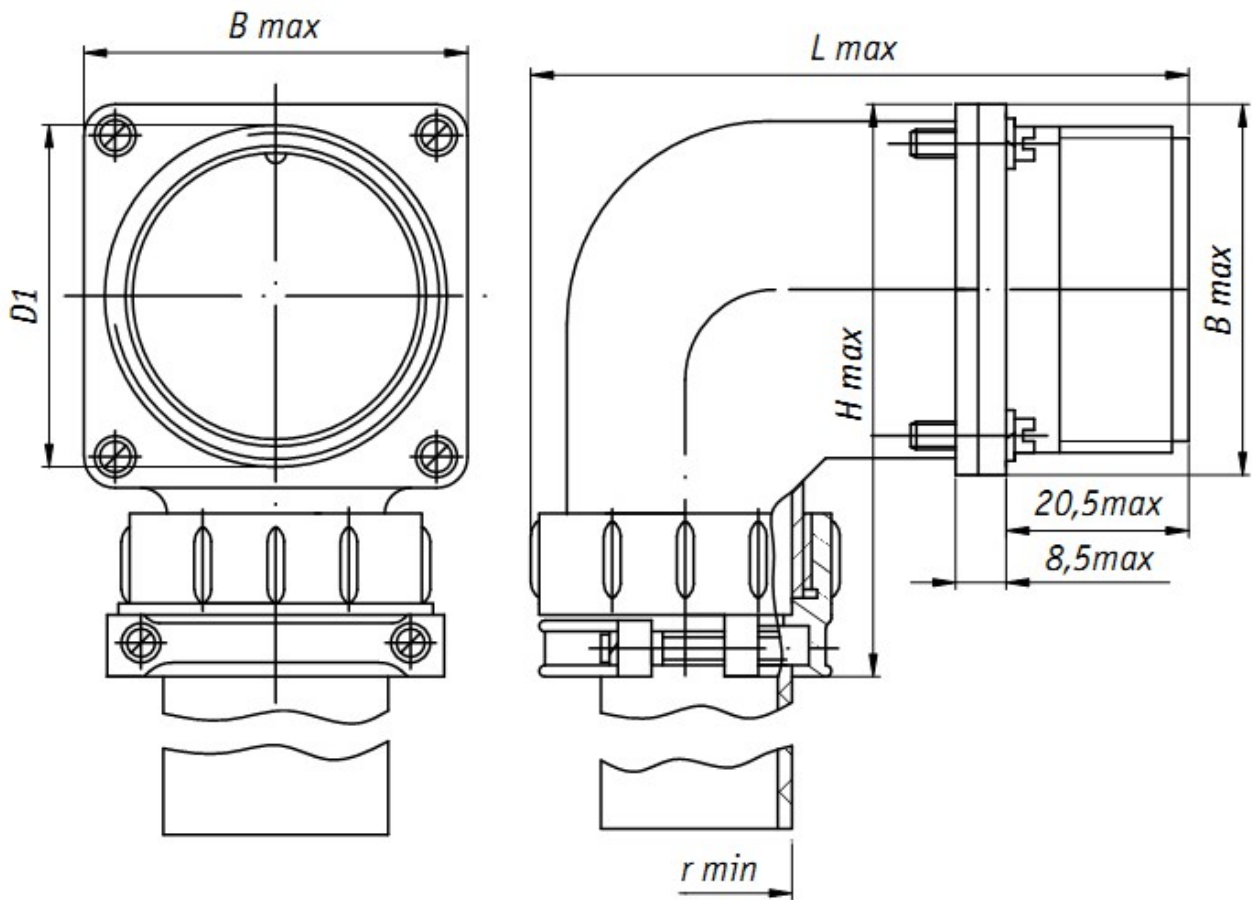

Shell size	B	H	D1	r	L
12	22	56	M16x1,5	4	59
16	25	57	M20x1,5	6	63
20	30	62	M24x1,5	12	71
28	38	76	M33x1,5	18	83
32	40	78	M36x1,5	18	83
36	42	80	M39x1,5	21	84
40	48	86	M45x1,5	23	90
48	58	96	M52x1,5	30	99
55	64	102	M60x1,5	38	106
60	68	106	M64x1,5	45	106

Plugs with straight EMI/RFI Backshell, P type

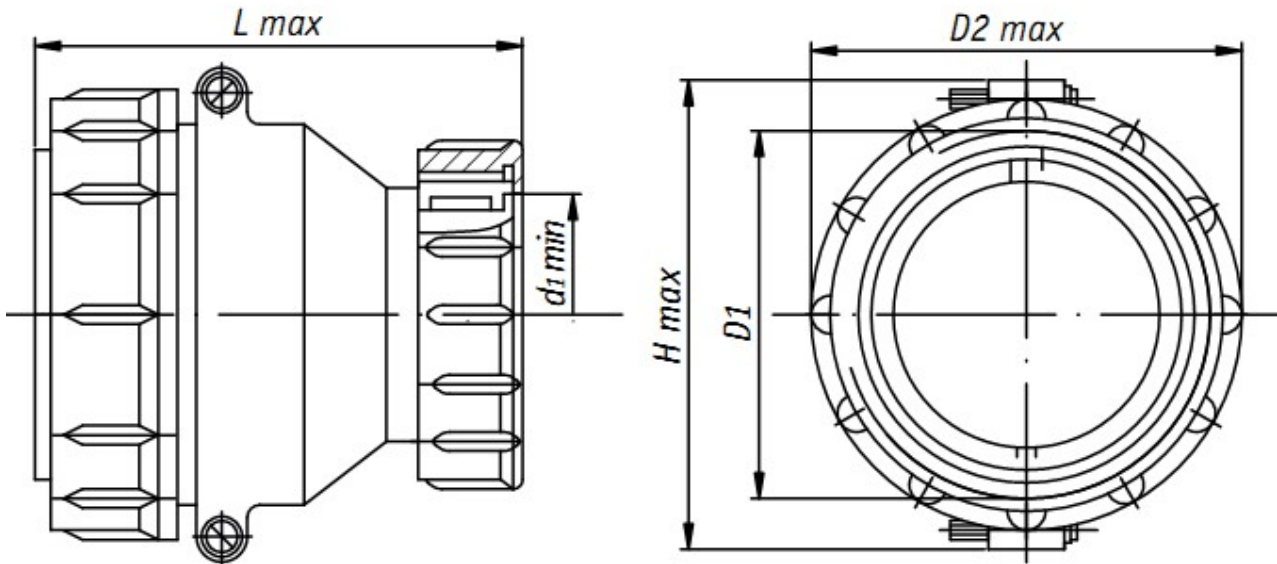

Shell size	H	D1	D2	d1	L
12	27	M16x1,5	21,5	4,0	56
16	31	M20x1,5	25,5	7,5	56
20	39	M24x1,5	29,5	12,5	60
28	51	M33x1,5	38,5	17,0	62
32	55	M36x1,5	41,5	19,0	64
36	58	M39x1,5	45,5	21,0	68
40	63	M45x1,5	52,5	25,0	70
48	71	M52x1,5	59,5	29,0	72
55	77	M60x1,5	67,5	40,0	72
60	83	M64x1,5	72,5	42,5	70

Plugs with straight non-shielding Backshell, Q type

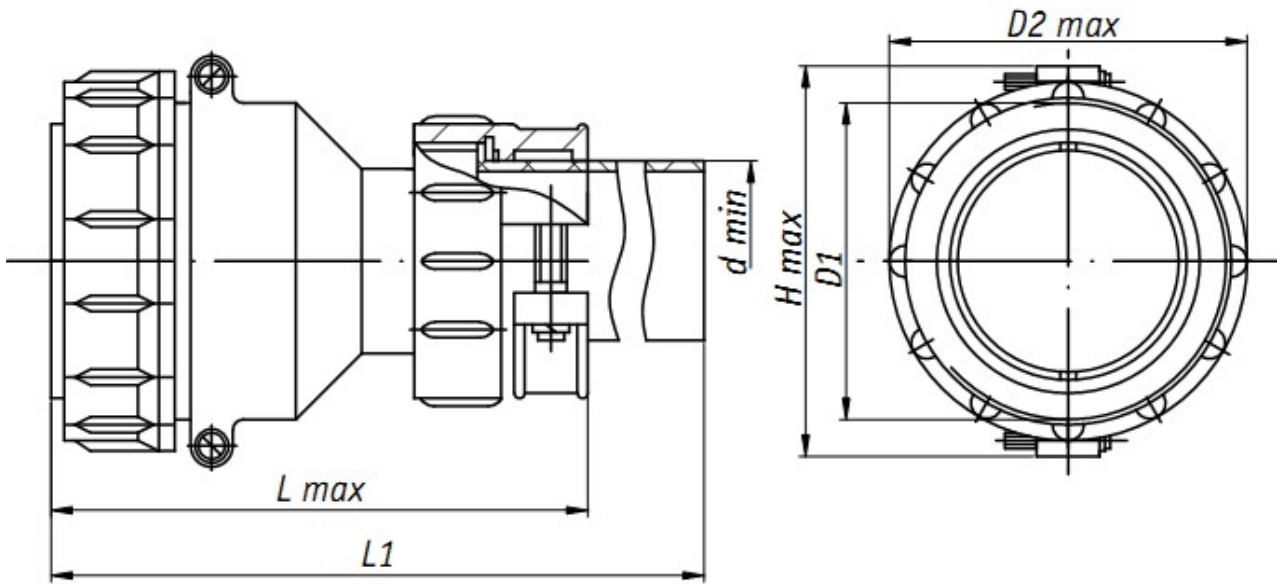

Shell size	H	D1	D2	r	L
12	27	M16x1,5	21,5	4	71
16	31	M20x1,5	25,5	6	71
20	39	M24x1,5	29,5	12	74
28	51	M33x1,5	38,5	18	79
32	55	M36x1,5	41,5	18	84
36	58	M39x1,5	45,5	21	86
40	63	M45x1,5	52,5	23	87
48	71	M52x1,5	59,5	30	89
55	77	M60x1,5	67,5	38	89
60	83	M64x1,5	72,5	45	87

Plugs with elbow EMI/RFI Backshell, R type

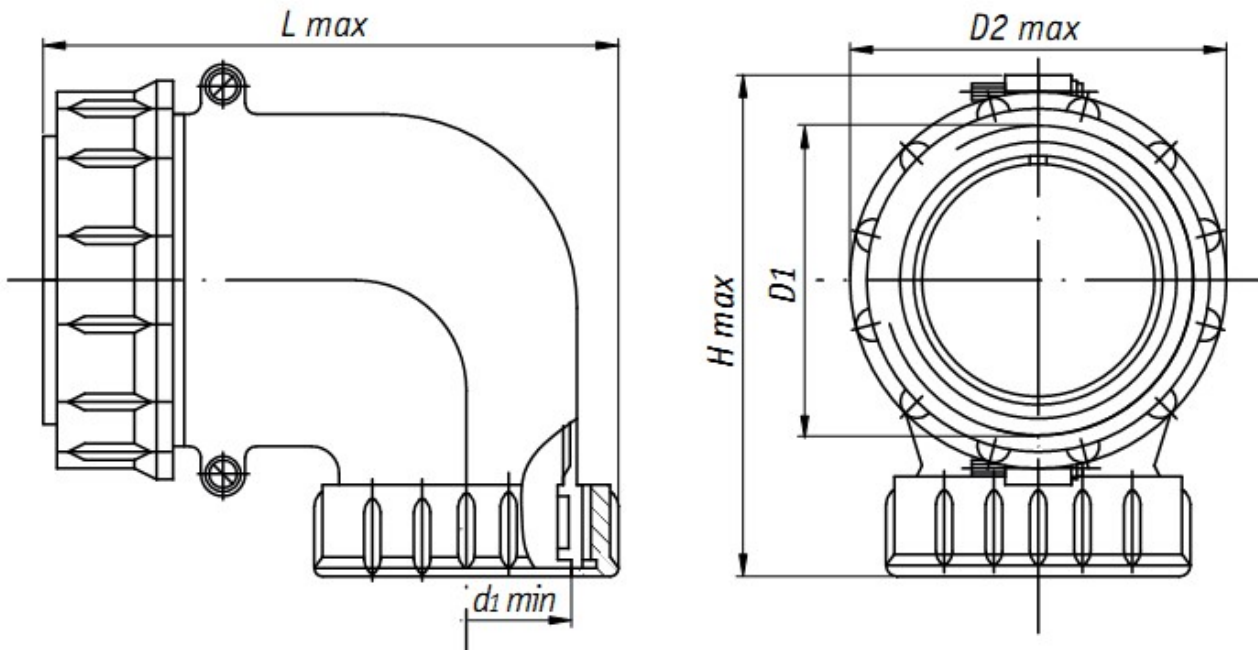

Shell size	H	D1	D2	d1	L
12	44	M16x1,5	21,5	4,0	56
16	48	M20x1,5	25,5	7,5	62
20	57	M24x1,5	29,5	12,0	70
28	69	M33x1,5	38,5	18,0	78
32	72	M36x1,5	41,5	18,0	78
36	74	M39x1,5	45,5	20,0	81
40	80	M45x1,5	52,5	22,5	86
48	87	M52x1,5	59,5	27,0	98
55	95	M60x1,5	67,5	38,0	103
60	101	M64x1,5	72,5	41,0	110

Plugs with elbow non-shielding Backshell, S type

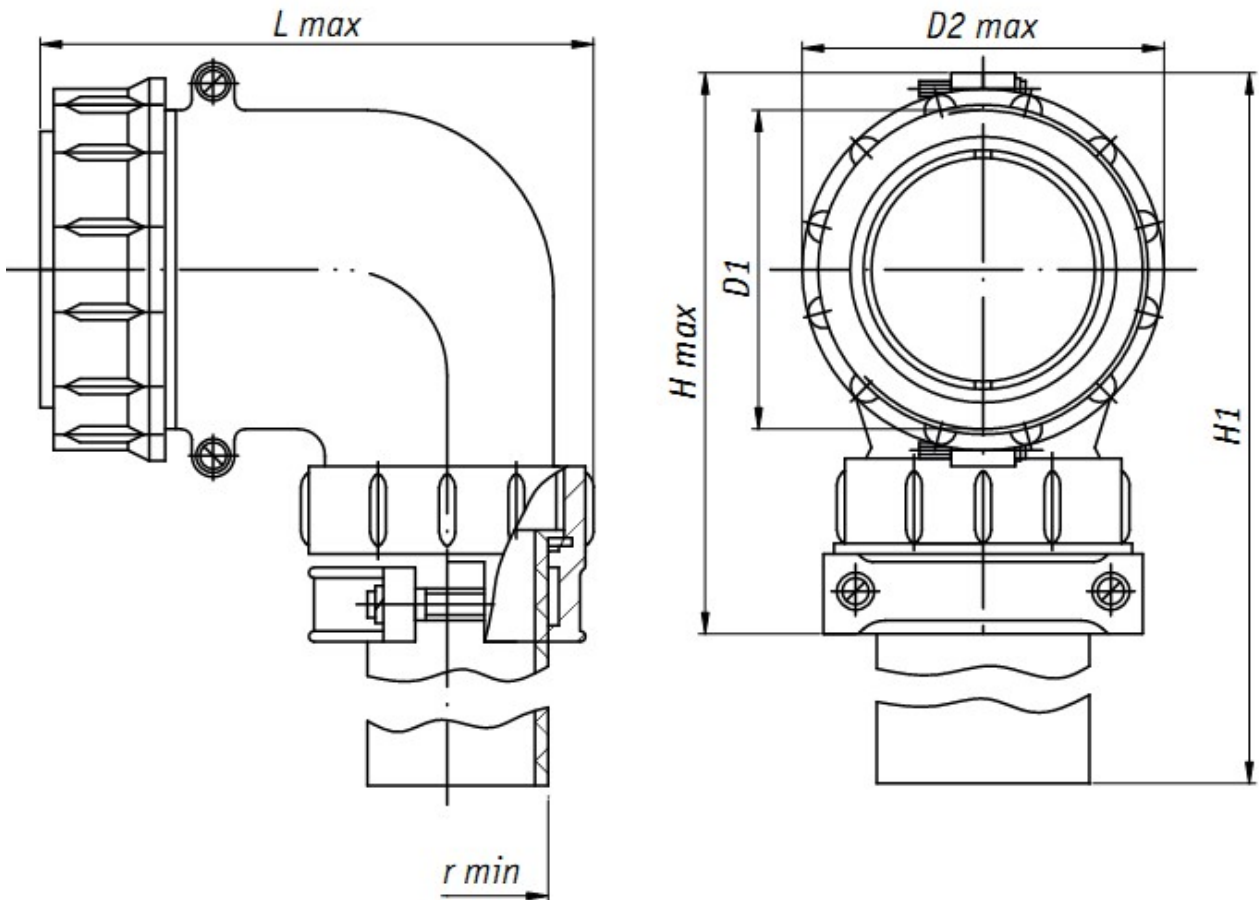

Shell size	H	D1	D2	r	L
12	59	M16x1,5	21,5	4	56
16	61	M20x1,5	25,5	6	63
20	71	M24x1,5	29,5	12	70
28	86	M33x1,5	38,5	18	80
32	90	M36x1,5	41,5	18	80
36	90	M39x1,5	45,5	21	81
40	96	M45x1,5	52,5	23	87
48	105	M52x1,5	59,5	30	98
55	112	M60x1,5	67,5	38	104
60	118	M64x1,5	72,5	45	113

CÔNG TY TNHH RỒNG VÀNG TECHNOLOGY

**Địa chỉ: 48/5 Vĩnh Xuân, Phường Vĩnh thái,
Thành Phố Nha Trang, Tỉnh Khánh Hòa**

SĐT: +84 79.219.2707

www.rong-vang-technology.vn

www.rong-vang-technology.vn